

Fließbecher für Lackierpistolen

Pistolentyp		QCC/OHNE Feingewinde passend für: SATAjet X 5500, SATAjet 5000 B, jet 4000 B, jet 3000 B, jet 2000, jet 1000 B, jet 100 B, , jet RP, SATAMinijet 4400 B	QCC/MIT Feingewinde passend für: SATAjet 2000, jet RP, KLC, LM 2000 B, jet 90-2	SATAjet B, jet GR, jet NR 95	SATAMinijet 3000 B, minijet 1 - 4, jet 20 B
Füllver- mögen	Art. Nr.				
Kunststoff-Mehrwegbecher					
0,125 l	197541				
0,125 l	125443				
0,3 l	48587				
0,3 l	120675				
0,3 l	128470				
0,6 l	49379				
0,6 l	27243		1004960 		
Mehrzweckbecher					
0,3 l	1010553				je 60 x 
0,3 l	1010561				je 60 x 
0,3 l	1010389	je 40 x 		 ⊕  125211	
0,3 l	1010397	je 40 x 		 ⊕  125211	
0,3 l	1010420	je 100 x 		 ⊕  125211	
0,3 l	1010404	je 100 x 		 ⊕  125211	
0,6 l	1010438	je 60 x 		 ⊕  125211	 ⊕  135798
0,6 l	1010488	je 60 x 		 ⊕  125211	 ⊕  135798
0,9 l	1011973	je 40 x 		 ⊕  125211	 ⊕  135798
0,9 l	1011981	je 40 x 		 ⊕  125211	 ⊕  135798

Alle Preise sind unverbindliche Preisempfehlungen. Irrtümer, technische Änderungen und Druckfehler vorbehalten.

RPS® Adapter für SATA Lackierpistolen

Pistolentyp		QCC/OHNE Feingewinde passend für: SATAjet 5000 B, jet 4000 B, jet 3000 B, jet 2000, jet 1000 B, jet 100 B, jet RP, SATAMinijet 4400 B	QCC/MIT Feingewinde passend für: SATAjet 2000, jet RP, KLC, LM 2000 B, jet 90-2	SATAjet B, jet GR, jet NR 95	QCC MIT Feingewinde für: SATAMinijet 3000 B, minijet 1 - 4, jet 20 B	
Füllvermögen	Art. Nr.					
Alu-Mehrwegbecher						
0,15 l	198911					
0,15 l	125948					
0,75 l	6601					
0,75 l	137729		1013432			
1,0 l	46631					
1,0 l	96685		1013440			
	71555	Kunststoffdeckel (Verpackungseinheit 3 Stück) für 0,75 l und 1,0 l Alu-Mehrwegbecher				

















RPS® Adapter für SATA Lackierpistolen

Adapter mit QCC für SATA Lackierpistolen ohne QCC zum schnellen Wechsel von SATA RPS 0,9 l und 0,6 l und 0,3 l "Standard"		SATA										
		SATAjet B / GR	SATAjet H / SATAjet 1000 H	SATAMinijet 2, 3, 4, SATAMinijet 3000, SATjet 20 B	SATAMinijet 1000 H	SATAjet 2000 HVLP ohne QCC	SATAjet RP ohne QCC	SATA LM 2000 HVLP/RP	SATA KLC HVLP/RP, KLC P	SATAjet 90	SATAjet B NR 92 HVLP, NR 95 HVLP	SATA LM B 92
	125211 (Nr. 1) M 16 x 1,5 Innengewinde	X									X	
	125237 (Nr. 2) M 16 x 1,5 Außengewinde					X	X	X	X	X		
	133595 (Nr. 7) 12 x 1,5 Außengewinde											X
	135798 (Nr. 10) M 10 x 1 Außengewinde			X								
	188318 (Nr. 17) G 1/4 Innengewinde				X							

(Nr. ...) Adapter Nummern

Alle Preise sind unverbindliche Preisempfehlungen. Irrtümer, technische Änderungen und Druckfehler vorbehalten.

RPS® Adapter für Fremdpistolen

Adapter mit QCC für Fremdpistolen zum schnellen Wechsel von SATA RPS 0,9 l und 0,6 l und 0,3 l "Standard"	DeVilbiss				IWATA				Walcom		Kremlin	Graco	Optima	Sharpe	Sagola			Eminent	Asturo	Airgunsa	Dux
	PHI, GTI, GPP, GRV, GRHV 510	SRI	Starting Line HVP Spray Gun	Starting Line Mini Spray Gun	W 400, WR 400, LPA 94, VXL Primer Gun, LPH 400	W 300, LPH 300, LS 400 Supernova, WS 400	W 100, LPH 100	LPH 80	FX GEO, FX HVP	Genesis Carbon	M 21 G	3M PPS	Optima 800, 900	Finex FX 300	Platinum, Titanium	475 Mini-Gun	403 G, 433 G, 434 G, 444 G, 450 G, 4100 G, 4400 G Extreme, 4500 G Extreme	E13	OM Green	AZ40 HTE	Fließbeheerpistole
 125211 (Nr. 1) M 16 x 1.5 Innengewinde					X																
 125237 (Nr. 2) M 16 x 1.5 Außengewinde									X												
 125252 (Nr. 3) 3/8" Außengewinde	X																				
 125278 (Nr. 4) 1/4" Außengewinde					X												X		X		
 125294 (Nr. 5) M 12 x 1 Außengewinde								X										X			
 126326 (Nr. 6) 3/8" Außengewinde											X										
 133595 (Nr. 7) 12 x 1.5 Außengewinde																X					X
 133827 (Nr. 8) G 3/8" Innengewinde												X	X								
 135111 (Nr. 9) NPSF 3/8" - 18 Außengewinde														X							
 135798 (Nr. 10) M 10 x 1 Außengewinde															X						
 150136 (Nr. 13) M 16 x 1.5 Außengewinde			X																		
 150151 (Nr. 14) M 11 x 1 Außengewinde				X																	
 164608 (Nr. 15) 7/16" - 14 UNC Außengewinde		X																			
 188664 (Nr. 18) M 18 x 1.5 Innengewinde																X					
 193276 (Nr. 19) 1/8" Außengewinde							X														
 215079 (Nr. 20) 1/4" Außengewinde										X											

(Nr. ...) Adapter Nummern

Alle Preise sind unverbindliche Preisempfehlungen. Irrtümer, technische Änderungen und Druckfehler vorbehalten.

SATA® Rührwerksbecher

SATA Rührwerksbecher		
9951	SATA Rührwerksbecher, Anbausatz für SATAjet B/ GR	
29926	SATA Rührwerksbecher Anbausatz für SATAjet X 5500, jet 5000 B, jet 4000 B, jet 3000 B, jet 2000, jet 1000 B, jet 100 B, jet RP	

Art. Nr./Bez.
1503
Senkschraube, Edelstahl
1826
Tropfsperre (Verpackungseinheit 4 Stück)
2188
Spindel
9951
SATA Rührwerksbecher, Anbausatz
20461
Luftschlauch, Kunststoff
21055
Rührflügel, kpl.
21063
Antriebsflügel, kpl. mit Schraube
21071
Dichtung Rührflügel, Becherrührwerk
29926
SATA Rührwerksbecher Anbausatz
44735
Senkschraube M 2,5 x 5, VA
44743
Rändelknopf
44792
Spindel für R-/B-Regulierung
51078
Regulierventil- Körper komplett für Becherrührwerk
53785
L-Stecknippelverschraubung, schwenkbar
53793
Kupplung mit G 1/8" (Innengewinde)
54049
Dichtungsring (Verpackungseinheit 4 Stück)
65557
Rändelknopf
123513
Manometer 0-10 bar, 40 mm für Regulierventil farbiges Klischee

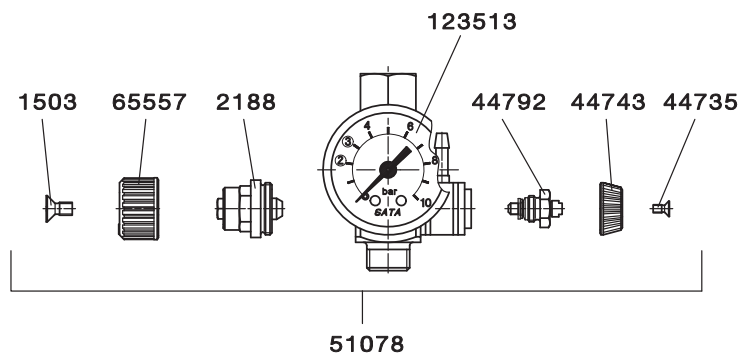
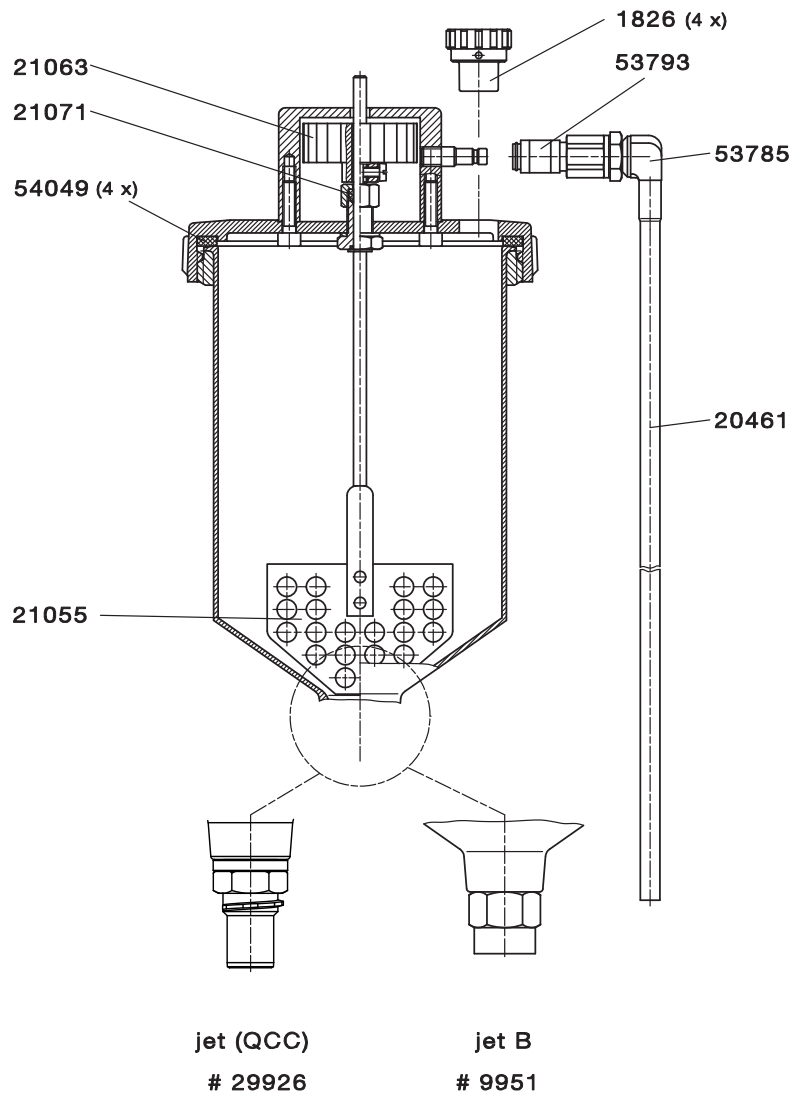

Alle Preise sind unverbindliche Preisempfehlungen. Irrtümer, technische Änderungen und Druckfehler vorbehalten.

SATA® BVD™

SATA BVD Anbausatz			
25775	SATA BVD Anbausatz mit QCC ohne Feingewinde für SATAjet X 5500, jet 5000 B, jet 4000 B, jet 3000 B, jet 2000, jet 1000 B, jet 100 B, jet RP		
57505	SATA BVD Anbausatz für SATAjet B		
22442	SATAjet B Düse 1,4E, ohne Becher		
73254	Reparatur-Set, für Regelarmatur spray master und BVD		

Art. Nr./Bez.
8268
Dichtring
20438
Sicherheitsventil PN 2
20461
Luftschlauch, Kunststoff
21014
Alu-Deckel, kpl.
21048
Druckbecher mit Deckel
25577
Druckbecher mit Deckel
53777*
Luftanschluss für Alu-Deckel
54049
Dichtungsring (Verpackungseinheit 4 Stück)
65920
Regelarmatur, kpl.
70664
Tropfsperre (Verpackungseinheit 10 Stück)
83493
Druckbecheranschluss, kpl.
83501
Luftschlauch, kpl. mit Druckbecheranschluss
120816
Druckablassschraube (Verpackungseinheit 2 Stück)
133983
Luftanschlussstück 1/4" (Außengewinde)
* bitte 8268 mitbestellen

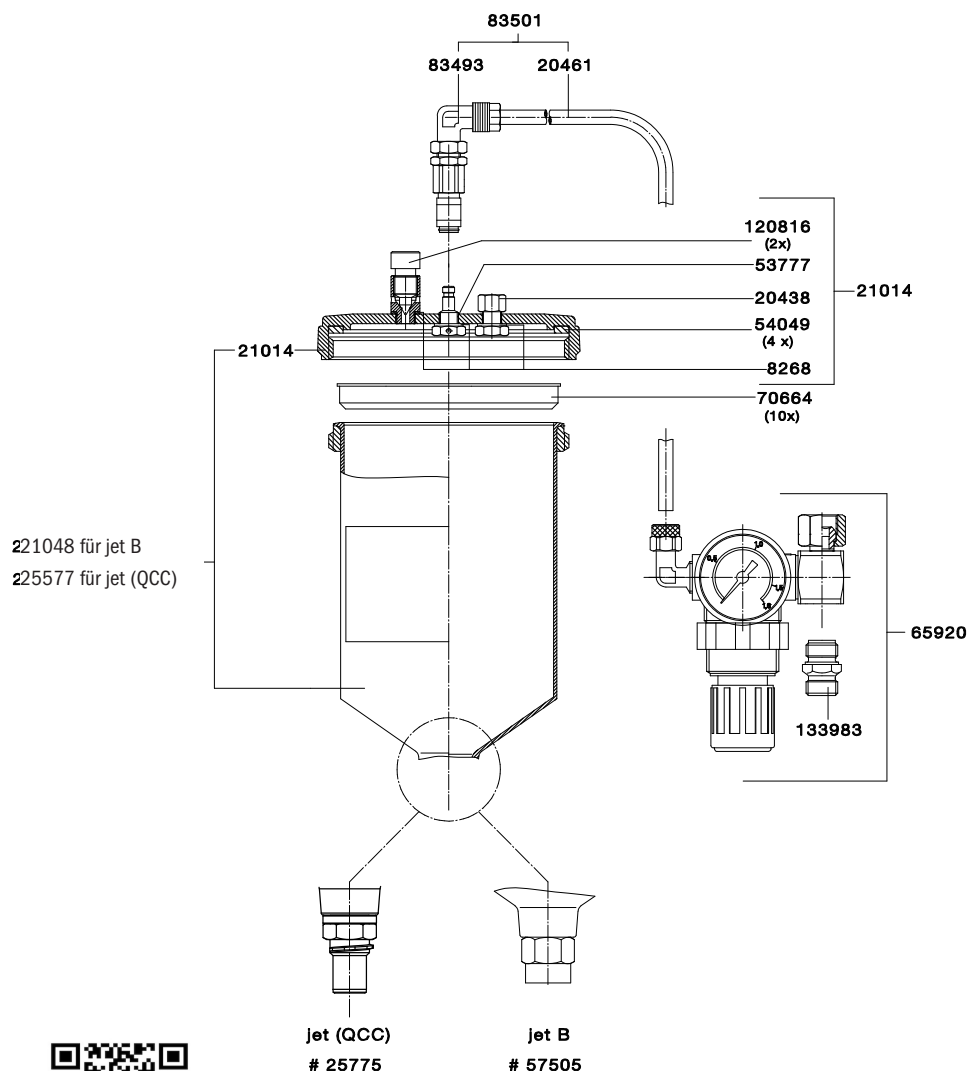

Planung, Beratung, Service und Ersatzteilversorgung

Michael Kessner
Profispritztechnik
Zum Peckenkamp 13
49328 Melle
Germany

Telefon +49 (0)5226 984576
Telefax +49 (0)5226 984579
Mobil +49 (0)160 2229990
E-Mail kontakt@mksl.de
Internet www.profispritztechnik.de

Alle Preise sind unverbindliche Preisempfehlungen. Irrtümer, technische Änderungen und Druckfehler vorbehalten.